

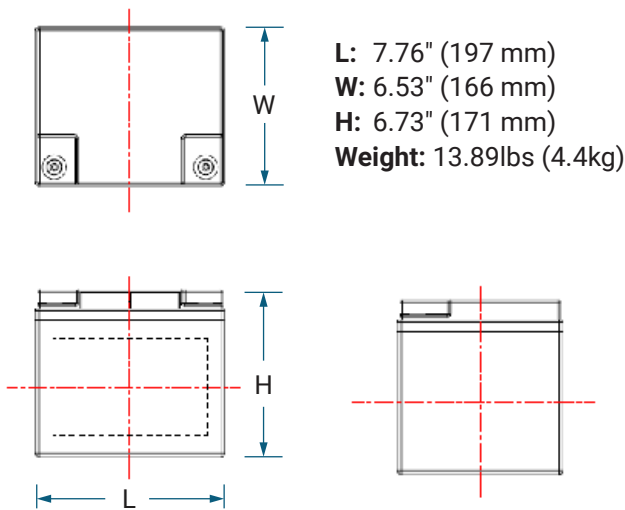

PSL-SC-12500 12.8V 50.0 AH

Rechargeable Lithium Iron Phosphate Battery
PSL-SC – LiFePO4 Series Connection Range

DIMENSIONS: inch (mm)



Dimensional Tolerances +/- 0.04 in. (+/- 1mm) for length and width
+/- 0.08 in. (+/- 2mm) for height

TERMINAL

T11 THREADED INSERT – 8mm STUD

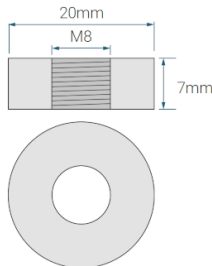

BATTERY FEATURES

- Super safe lithium iron phosphate (LiFePO4) chemistry reduces the risk of explosion or combustion due to high impact, over-charging or short circuit situation
- Battery Management System (BMS) controls the parameters of the battery to provide optimum safety by protecting against over-charging and over-discharging
- BMS enhanced design balances the battery cells, optimizing battery performance
- Higher capacity or voltage capability through parallel or serial connections
- Delivers twice the power of lead acid batteries, even at high discharge rates, while maintaining constant power
- Faster charging and lower self-discharge
- Up to 10 times more cycles than lead acid batteries
- Compact and only 40% of the weight of comparable lead acid batteries
- Rugged impact resistant ABS case

APPROVALS

- UL 1642 cell certificate
- IEC 62133 cell certificate
- UN 38.3 certified
- ISO9001:2015 - Quality management systems



INTELLIGENT BATTERY MANAGEMENT SYSTEM

The PSL-SC Series comes with an intelligent battery management system which monitors current and voltages during charge and discharge. This protects the battery from over-charge and over-discharge.

The BMS embeds smart balancing algorithms that control all cell voltages in the battery, making sure they are constantly at the same voltage level, optimizing battery capacity.

SERIAL CONNECTION CAPABLE

The SC series allows for up to 6 batteries connected in series or 4 in parallel, but not concurrently. The batteries must all be matched at voltage levels, capacity, state of charge, date of manufacturing, and chemistry.

APPLICATIONS

- Medical
- Solar
- Wind
- Mobility
- Data Center
- Transport
- Sports & Recreation
- Utility

CORPORATE HEADQUARTERS (USA AND INTERNATIONAL EXCLUDING EMEA)

Power-Sonic Corporation
365 Cabela Dr Suite 300,
Reno, Nevada 89523 USA
T: +1 619 661 2020
E: customer-service@power-sonic.com

POWER-SONIC EMEA (EMEA – EUROPE, MIDDLE EAST AND AFRICA)

Smitspol 4, 3861 RS Nijkerk,
The Netherlands
T NL: + 31 33 7410 700
T UK: + 44 1268 560 686
T FR: + 33 344 32 18 17
E: salesEMEA@power-sonic.com

SELECTING A BATTERY FOR APPLICATION

Selection of LiFePO4 Based on Current

Choosing the appropriate LiFePO4 battery for any application, whether the application is based on current draw or power draw, is easier with a LiFePO4 battery than with a sealed lead acid (SLA) battery. The capacity of a lithium battery, as illustrated by Figure 1, is substantially independent of the discharge current. Thus, the selection of the lithium battery is simply the discharge current requirement multiplied by the time over which the discharge current is required. For instance, if a 10A draw is required for 2 hours or a 5A draw is required for 4 hours, a 20Ah lithium battery is appropriate for the application.

The second aspect of a lithium battery that makes it easier to size for an application is that the cutoff voltage (as displayed in Figure 2) is 10V, independent of discharge rate. Whereas with an SLA battery, the voltage changes with discharge rate. The cut-off voltage of a lithium battery is also controlled via the protection circuit. It is good practice to set the cut-off voltage to be slightly higher than the recommended cut-off voltage. This will keep the battery from shutting down due to protection.

Selection of LiFePO4 Based on Power Draw

Choosing the appropriate lithium battery based on power draw is also easier than with an SLA battery. The voltage drop during discharge for a lithium battery is essentially constant, as shown in Figure 2. The constant voltage drop leads to a constant power through discharge, as power is voltage times current draw. As with capacity, power draw is a simple calculation for the selection of the battery. For instance, a voltage of a lithium battery can be assumed to be a constant 12.8 V during discharge, hence if 256 Wh are required for the application to be delivered for a 2 to 4 hour discharge a 10 Ah battery can be used (e.g. $12.8\text{ V} \times 5\text{ Ah} \times 4\text{ Hr} = 256\text{ Wh}$ and $12.8\text{ V} \times 10\text{ Ah} \times 4\text{ Hr} = 256\text{ Wh}$) to deliver constant power.

ENVIRONMENTAL FACTORS

Impact of Ambient Temperature on Capacity

The impact of ambient temperature on capacity is shown in Figure 3. In general, increasing temperature increases the capacity of a LiFePO4 battery. The effect is shown in the Discharge Specifications table. Discharging the battery below -10°C is not recommended. Depending on application, the self-heating of the battery may counteract the effects of the low temperature and extended the ambient temperature range over which the battery will discharge.

Cycle Life (Including the Effects of Ambient Temperature)

Cycle life in Figure 4 is to 100% Depth of Discharge (DoD) at 25°C , 45°C and 55°C . The cycle life at other DoD can be approximated by the ratio of the DoD to 100%, for example a 50% DoD at 25°C would result in 2000 cycles based on Figure 4. For temperatures other than those shown on the graph, an interpolation can be done at that temperature. For temperatures below 25°C , the cycle life at 25°C can be used.

When compared to an SLA battery at 25°C , a LiFePO4 battery's cycle life is ten times longer. Even at elevated temperatures, the LiFePO4's cycle life is still longer than an SLA's when at room temperature, as demonstrated in Figure 4. Therefore, in replacing an SLA with LiFePO4, the LiFePO4 will always have a longer cycle life.

CHARGING

Charging a LiFePO4 battery

The lithium battery follows a similar charge profile as an SLA battery. It starts with constant current (CC) followed by constant voltage (CV). The standard LiFePO4 profile is 0.2C CC charge to 14.6V, the a CV at 14.6V charge until the charge current declines to $\leq 0.05\text{C}$. A fast charge current of 1C may be used as necessary. Note that continual fast charging may shorten the battery life and therefore capacity. Any charger with a lithium setting is suitable.

However, when using an SLA charger the protocols used for charge initialization and maintenance must be considered.

The biggest difference between LiFePO4 and SLA is the way the battery responds upon initial charging when over-discharged, and the preferred maintenance when fully charged. Using an SLA charger with a de-sulfation setting will damage the battery, and chargers with an Open Circuit Voltage (OCV) detection setting may fail to wake up an over-discharged battery. After the end-of-charge, it is not necessary to keep the LiFePO4 battery on a float charge, but it may be maintained with a topping charge if the voltage drops. If a charger has a float setting, it will not damage the LiFePO4 battery.

CAPACITY OF LiFePO4 vs. LEAD ACID AT VARIOUS CURRENTS OF DISCHARGE

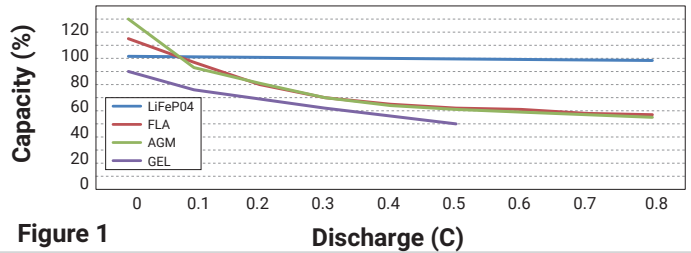

Figure 1

DISCHARGE VOLTAGE PROFILES AT VARIOUS RATES 25°C AMBIENT TEMPERATURE

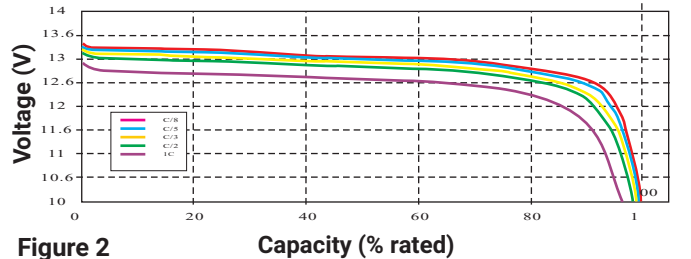

Figure 2

DISCHARGE VOLTAGE PROFILES AT 0.5C DISCHARGE RATE VARIOUS AMBIENT TEMPERATURES

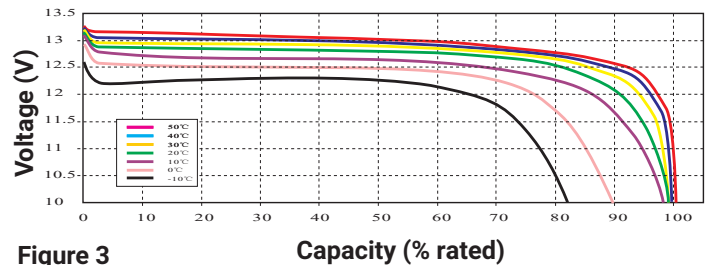

Figure 3

CYCLE LIFE vs. VARIOUS TEMPERATURE 0.2C CHARGE/0.5C DISCHARGE @ 100% DOD

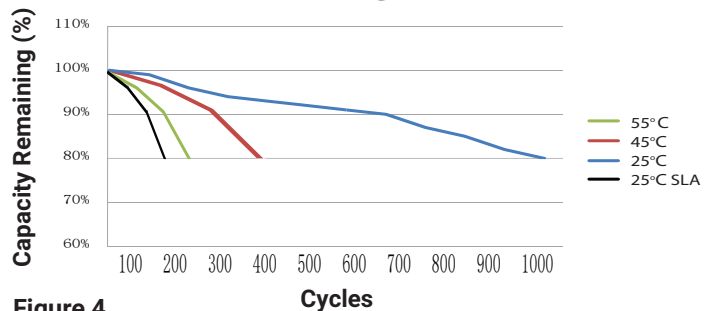

Figure 4

CHARGING CHARACTERISTICS (0.2C AMP @ 25°C)

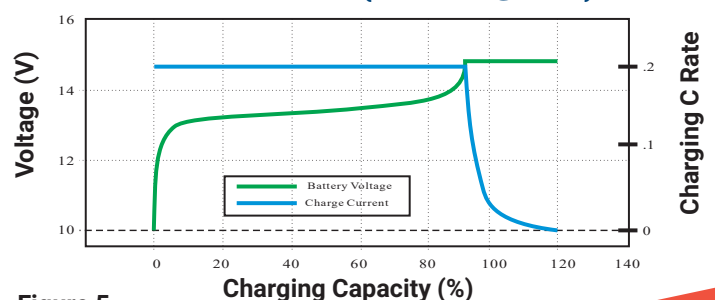

Figure 5

BATTERY MANAGEMENT SYSTEM

Electrical Characteristics

The battery management system (BMS) is a programmable circuit board used to protect the battery during charging and discharging. The protection is provided by monitoring voltages, current, lithium cell temperature and circuit board temperature and comparing the monitored values to predetermined limits used to protect the battery from damage. If one of the variables being monitored exceeds a limit, the BMS will disable either the charging or discharging circuit, depending on the state of the battery, to prevent current flowing into or out of the battery to protect the battery from damage. The battery will exit the protection mode based on the release method described BMS protections. All battery level maximum and minimum voltages are based on a cell level specification. Due to cell imbalances, the voltages will fall into a range but may never be the exact numbers as specified in this specification.

GENERAL PERFORMANCE SPECIFICATIONS

Nominal Voltage	12.8V
Rated Capacity	50AH at a Constant Current of 0.2C to 10V
Life Expectancy (Years)	5 years (1 cycle/day)
Cycle Life (100% DoD)	2000 cycles
Assembly Method	4S14P
Housing Material	ABS
Series Connection	4 in series
Parallel Connection	4 in parallel
Internal Monitoring	BMS

STORAGE SPECIFICATIONS

Self-discharge Rate	<3% / Month	
Storage Temperature Range	<3 Months	-5-35°C
	<1 Year	0-25°C
Recommended Storage SOC	Recommended storage range is 30-50% State of Charge. We recommend cycling the battery once every six months if it is in long-term storage.	
Storage Condition	The batteries should be stored open circuit, and protected against the possibility of a short between the terminals. If cycling is not possible, the next preferred method is to charge once every six months.	

CHARGE SPECIFICATIONS

Charge Temperature Range	0-45°C
Charge Voltage	14.6V
Recommended Float Charge Voltage (For Standby Use)	13.8V
Max Charge Current	50A at 20°C
Recommended Charge Current	0.2C
Charge Cut-off Voltage	15.6V
Standard Charge	0.2C constant current charge to 14.6V then constant voltage 14.6V charge until charge current declines to ≤0.05C

DISCHARGE SPECIFICATIONS

Discharge Temperature Range	-20-60°C	
Recommended Output Voltage Range	12.8-10V	
Max Continuous Discharge Current	50A at 20°C	
Discharge Cut-off Voltage	10V	
Standard Discharge	Constant Current 0.2C	
Discharge Temperature Characteristics	-20°C	70% Capacity
	0°C	90% Capacity
	25°C	100% Capacity
	60°C	102% Capacity

BMS SPECIFICATIONS

	Minimum	Typical	Maximum	Time Delay	Protection Mode	After Release	
Voltage Protection	Over Voltage	3.85V/Cell	3.9V/Cell	3.95V/Cell	2s	Turn off the charging circuit	
	Over Voltage Release	3.55V/Cell	3.6V/Cell	3.65V/Cell	2s		Turn on the charging circuit
	Under Voltage	1.95V/Cell	2.0V/Cell	2.05V/Cell	2s	Turn off the discharging circuit	
	Under Voltage Release	2.45V/Cell	2.5V/Cell	2.55V/Cell	2s		Turn on the discharging circuit
Over Current Charge Protection	1st Protection	50A	55A	60A	10s	Turn off the charging circuit	
	Over Current Release		0A		15s		Turn on the charging circuit
	2nd Protection	70A	75A	80A	3s	Turn off the charging circuit	
	Over Current Release		0A		15s		Turn on the charging circuit
Over Current Discharge Protection	1st Protection	70A	75A	80A	10s	Turn off the discharging circuit	
	Over Current Release		0A		15s		Turn on the discharging circuit
	2nd Protection	95A	100A	105A	3s	Turn off the discharging circuit	
	Over Current Release		0A		15s		Turn on the discharging circuit
	3rd Protection	145A	150A	155A	31ms	Turn off the discharging circuit	
	Over Current Release		0A		15S		Turn on the discharging circuit
Short Circuit Protection	1st Short Circuit	210A		220A	500 μ s	Turn off the discharging circuit	
	Short Circuit Release		0A		30s		Turn on the discharging circuit
	2nd Short Circuit	280A		290A	250 μ s	Turn off the discharging circuit	
	Short Circuit Release		0A		30s		Turn on the discharging circuit
Charging Temperature Protection	Over Temperature Charge (Battery)	55 $^{\circ}$ C	60 $^{\circ}$ C	65 $^{\circ}$ C	2s	Turn off the charging circuit	
	Over Temperature Charge Release (Battery)	40 $^{\circ}$ C	45 $^{\circ}$ C	50 $^{\circ}$ C	2s		Turn on the charging circuit
	Low Temperature Charge (Battery)	-2 $^{\circ}$ C	0 $^{\circ}$ C	2 $^{\circ}$ C	2s	Turn off the charging circuit	
	Low Temperature Charge Release (Battery)	0 $^{\circ}$ C	2 $^{\circ}$ C	4 $^{\circ}$ C	2s		Turn on the charging circuit
Discharging Temperature Protection	Over Temperature Discharge (Battery)	60 $^{\circ}$ C	65 $^{\circ}$ C	70 $^{\circ}$ C	2s	Turn off the discharging circuit	
	Over Temperature Discharge Release (Battery)	50 $^{\circ}$ C	55 $^{\circ}$ C	60 $^{\circ}$ C	2s		Turn on the discharging circuit
	Over Temperature Discharge (Circuit)	80 $^{\circ}$ C	85 $^{\circ}$ C	90 $^{\circ}$ C	2s	Turn off the discharging circuit	
	Over Temperature Discharge Release (Circuit)	65 $^{\circ}$ C	70 $^{\circ}$ C	75 $^{\circ}$ C	2s		Turn on the discharging circuit
	Low Temperature Discharge (Battery)	-22 $^{\circ}$ C	-20 $^{\circ}$ C	-18 $^{\circ}$ C	2s	Turn off the discharging circuit	
	Low Temperature Discharge Release (Battery)	-20 $^{\circ}$ C	-18 $^{\circ}$ C	-16 $^{\circ}$ C	2s		Turn on the discharging circuit

TESTING CONDITIONS

Electrical Characteristics

Ambient Temperature: 20±5°C

Humidity: 45-85%

Testing Parameters

Tests should be conducted with batteries that have less than 5 cycles before the test.

STANDARD CHARGE AND DISCHARGE

Standard Charge

Charge at 0.2C constant current until the battery reaches 14.6V. The battery then charges at constant voltage of 14.6V while tapering the charge current. Charging will end when the current has tapered to 0.05C. The battery should be charged between 0 °C and 45 °C, then rest for 30 minutes before discharging. Do not exceed the max charging current, voltage, or temperature limits as specified in this document. Do not reverse-polarity charge the battery.

Standard Discharge

Battery should be discharged at a constant current of 0.2C to 10.0V at 20±5 °C, then rest for 30 minutes before charging.

Storage

The batteries should be stored open circuit, and protected against the possibility of a short between the terminals. The battery should be charged once every 6 months if not in use to prevent over-discharging. They batteries should be stored at room temperature, and charged to 30-50% SOC.

Warnings

If the battery is over-charged and over-discharged too frequently, this will affect the long-term performance and capacity of the battery. If the battery is stored for too long, reduced capacity and performance can be expected. It is important to cycle the battery at least once every 6 months and stored at the appropriate SOC to prevent deterioration to the battery.

WARNINGS AND TIPS

Short Circuit

Do not short circuit battery. If the battery is short-circuited, it causes excessive heat which will damage the battery and possibly it's surroundings.

Warnings

Do not drop, throw, or crush battery.

Do not throw the battery into water or fire.

Keep battery away from heat sources, high voltage, and other high-temperature sources.

Do not leave the battery exposed to sunlight for extended periods of time.

Do not attempt to disassemble the battery.

Batteries in strings must always be matched by chemistry, capacity, voltage, and SOC.

Do not connect in reverse polarity.

Tips

Keep the battery away from high-temperature environments. This can cause over-heating, fire, reduction in battery life, and/or loss of other battery functions.

Use matched or suggested charger for this battery.

When battery runs out of power, charge your battery in a timely manner (15 days or less). This will prevent premature aging of the battery.

Stop using the battery immediately if it emits a burning smell, too much heat, or appears distorted.

FURTHER INFORMATION

Please refer to our website www.power-sonic.com or email us at technical-support@power-sonic.com for a complete range of useful downloads, such as product catalogs, material safety data sheets (MSDS), ISO certification, etc.

PSL-SC BATTERIES PARALLEL CONNECTION GUIDE

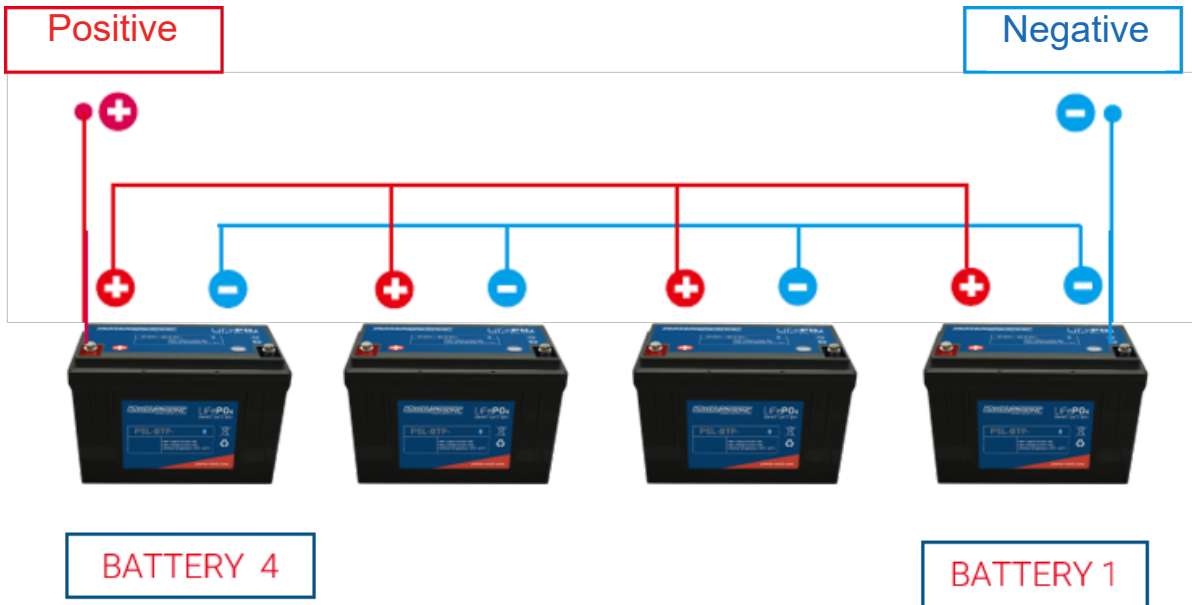

PARALLEL CONNECTION GUIDELINES

CAUTION:

Severe damage to the battery, short circuiting and sparking will happen if the batteries are not connected correctly or properly maintained. We recommend assembly be completed by fully trained professionals only.

Do not reverse connect the anode and cathode, as this will damage the batteries and/or any equipment connected.

DO NOT connect the batteries in parallel AND series at the same time.

Before install

Ensure wires can withstand twice the capacity rating of the battery. (Ex: PSL-SC-12500 has a capacity of 50Ah, so the wire must be able to withstand 100A.)

Charge all batteries with 14.6V per standard charge.

Ensure all batteries have the same voltage level by fully charging each battery prior to connecting in parallel. (Voltage difference <0.2V)

Install

Make sure the connections are tight and the connector is protected from corrosion, wear, and seismic situations. Connecting impedance <0.1mΩ

DO NOT connect more than 4 batteries per circuit.

Maintenance

Make sure capacity stays within 50-60% when storing the batteries. The temperature should be 0-35° C, humidity 75-85% and fully charged every 3 months and discharged to 50-60% capacity.

Once a year, the batteries should be removed from string and individually charged. The voltage difference upon reassembly should be no more than 0.2V.

PSL-SC BATTERIES SERIES CONNECTION GUIDE

Positive

Negative

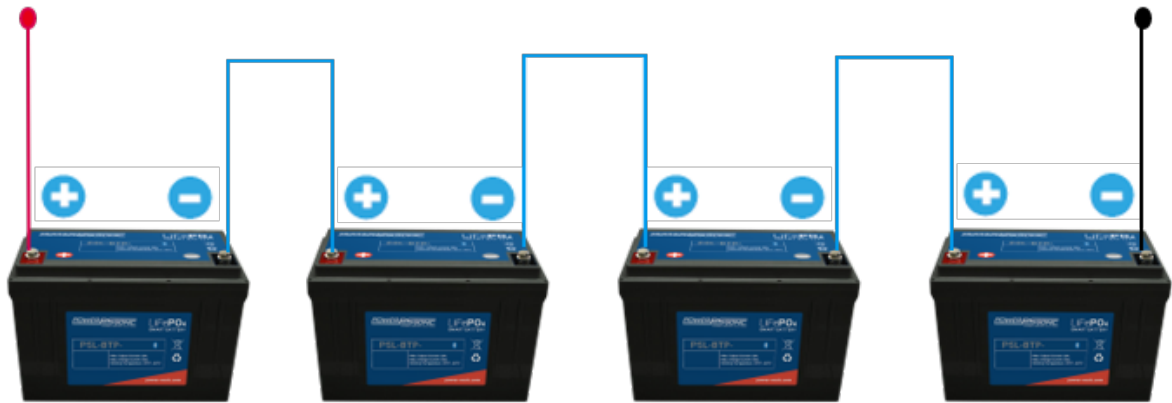

BATTERY 4

BATTERY 1

SERIES CONNECTION GUIDELINES

CAUTION:

Severe damage to the battery, short circuiting and sparking will happen if the batteries are not connected correctly or properly maintained. We recommend assembly be completed by fully trained professionals only.

Do not reverse connect the anode and cathode, as this will damage the batteries and/or any equipment connected.

DO NOT connect the batteries in parallel AND series at the same time.

Before install

Ensure wires can withstand twice the capacity rating of the battery. (Ex: PSL-SC-12500 has a capacity of 50Ah, so the wire must be able to withstand 100A.)

Charge all single batteries with 14.6V per standard charge and series batteries at a voltage of 14.6 times the number of batteries in series.

Ensure all batteries have the same voltage level by fully charging each battery prior to connecting in series. (Voltage difference <0.2V)

Install

Make sure the connections are tight and the connector is protected from corrosion, wear, and seismic situations. Connecting impedance <0.1mΩ

DO NOT connect more than 4 batteries per circuit for the PSL-SC line and no more than 2 per circuit for the PSL-SH line.

Maintenance

Make sure capacity stays within 50-60% when storing the batteries. The temperature should be 0-35° C, humidity 75-85% and fully charged every 3 months and discharged to 50-60% capacity.

Once a year, the batteries should be removed from string and individually charged. The voltage difference upon reassembly should be no more than 0.2V.